

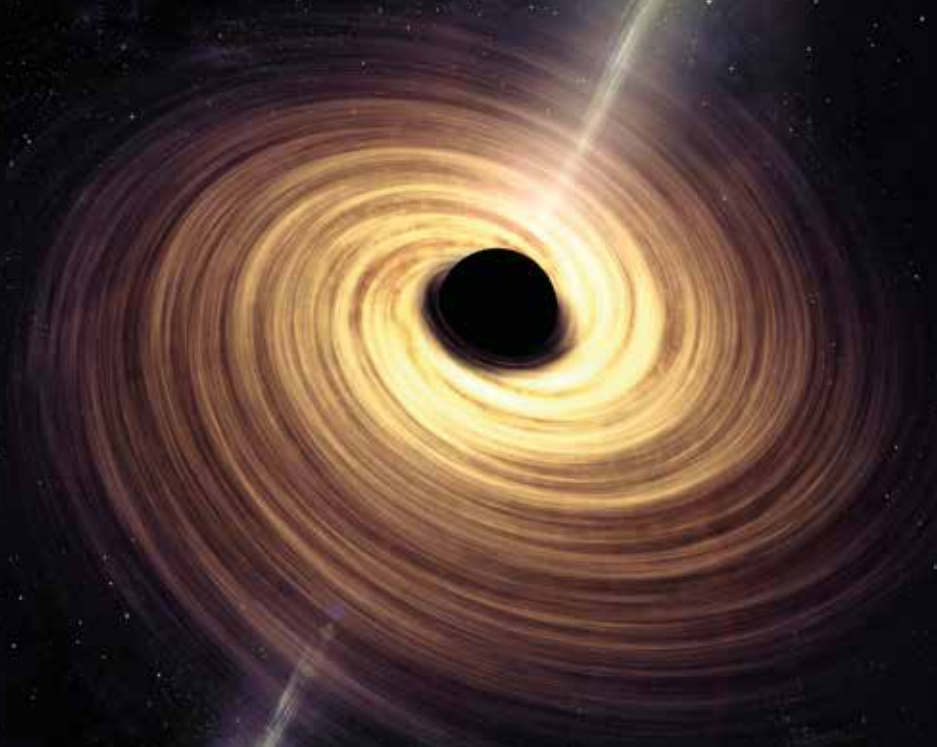

QUANTUM

P U R I T Y



ELEGRO
ENGINEERING



TAKING THE QUANTUM LEAP

Quantum harnesses a revolutionary leap in technology. Already used and approved by high-profile industries such as hospitals and drinking water purification companies, it has now been adopted by Elecro and brought to you!

Take pool hygiene and water clarity to the ultimate level

Pool water that sparkles like diamonds in a way you've never seen

Quantum uses new Nano Crystal technology: a prime focus of the science world today; possessing the power to sterilise sewerage into drinking water without the use of chemicals. In fact, one of the many benefits of the Quantum is a significant reduction of residual chemicals, such as chlorine or hydrogen peroxide.

Built to be installed easily into your existing set-up, the Quantum is completely safe and significantly more powerful than chlorine, hydrogen peroxide, UV or ozone. Photocatalytic Oxidisation has an immensely powerful effect with the ability to instantaneously destroy viruses, bacteria and pathogens, and more astoundingly possessing the ability to convert sun tan oil, urea and other contaminants back in to their harmless molecular form.

Meticulously designed, Elecro have developed the first cost-effective, photocatalytic oxidiser specifically for the swimming pool industry, for a toxin free swimming sensation. Not only does it eliminate undesirable side-effects such as sore eyes, itchy dry skin, discoloured hair and strong odours, but it also makes water crystal clear, and most importantly it creates no risk to the lungs or health of bathers and swimming pool attendants.

Take the Quantum Leap and refuse compromise!



PRODUCT OVERVIEW

- **Safe:** Only pure, sterilised water is released from the reaction chamber.
- **Clean:** Makes the water sparkle like diamonds in a way never seen before.
- **Efficient:** Consumes no more electricity than a common light bulb, providing continuous savings.
- **Effective:** No micro-organisms are safe! The only technology available with an unparalleled ability to instantly destroy all viruses, bacteria and pathogens, and like no other device, will break down oil and contaminants into their harmless molecular form.
- **Powerful:** The sterilising effect of the Quantum photocatalytic oxidiser [PCO] exceeds the effects of boiling water.
- **Easy to Use:** Comes pre-assembled with all necessary sensors and control components: no complicated parts to piece together. The bulb replacement indicator will alert after 14,000 hours of use.
- **Built to last a Lifetime:** Corrosion resistant, regardless of any salt or chemical concentrations in the water. As the reaction surface is truly catalytic and therefore it is never consumed or altered.

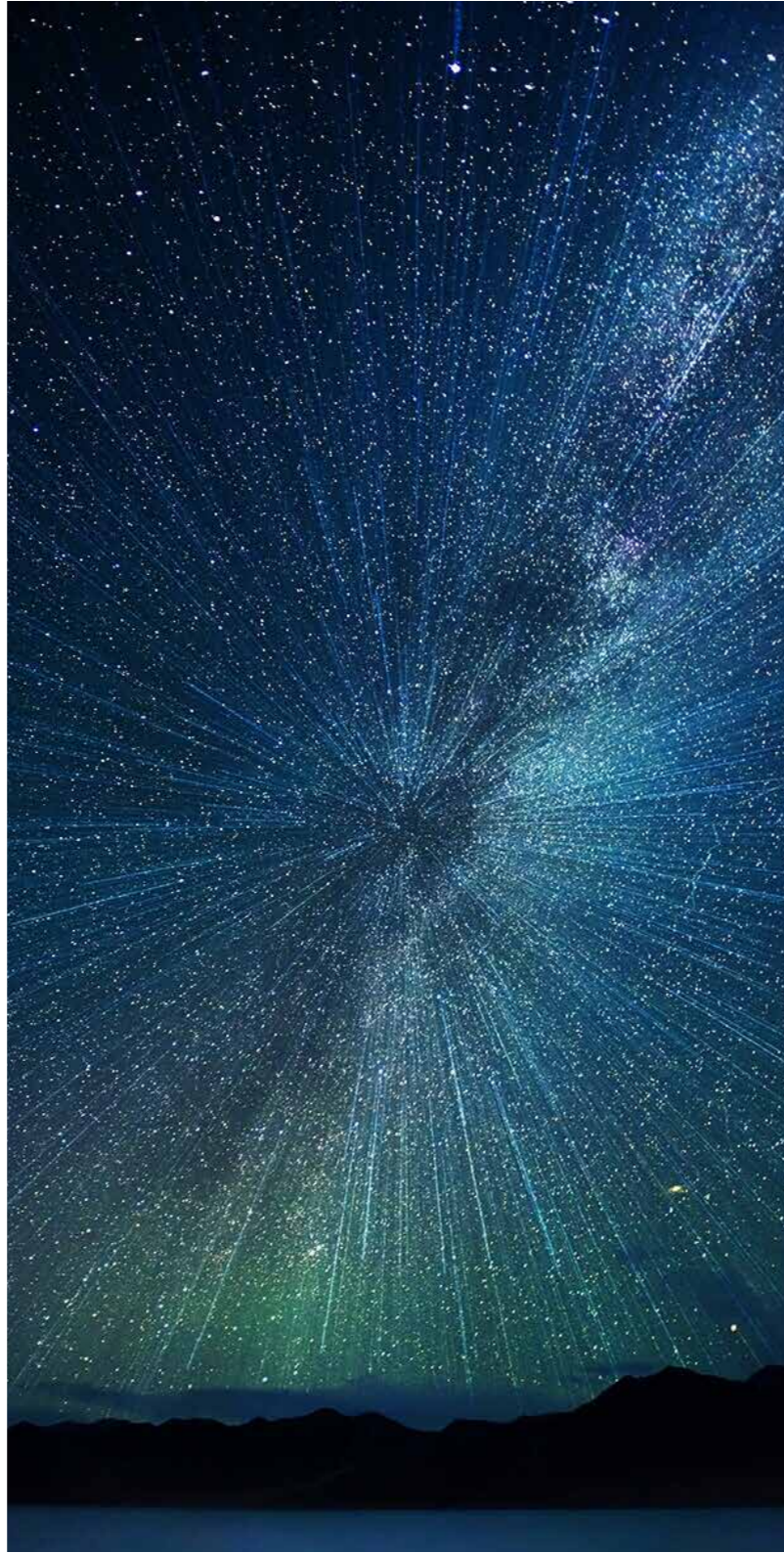

WHY QUANTUM?

With a wide range of products available on the market that offer a variety of technologies to sanitise swimming pool water, how do you decide what method is best for you? The table below identifies some key players including chlorine, UV, ozone, hydroxyl radicals, and photocatalytic oxidisation at the top as the strongest and most effective sterilising agent in existence.

Sterilising swimming pools has always been a matter of finding a balance between using chemicals strong enough to destroy the most harmful germs that may cultivate in the pool, whilst at the same time limiting the negative impact of the treatment method on humans. Currently, chlorine is the most widely used sterilisation method. The side effects though can be irritation to the skin and eyes, and the inconvenience of continually topping up the dosage. Chlorine and ozone are also known to release gas that hovers above the swimming pool and can be hazardous to breathing. In contrast the photocatalytic oxidisation reaction is contained within the reaction chamber releasing only pure, fresh water, clean enough to drink.

Quantum's advanced cleaning technology replicates nature's own technique for sterilising our planet, making it habitable. A photocatalytic oxidiser, known by scientists as "Nature's Silver Bullet," neutralises what chlorine cannot and achieves exponential reductions in unwanted bacteria, pathogens and viruses never seen before. Chlorine, ozone and UV are ineffective against Naegleria Fowleri and Adenovirus, whereas photocatalytic oxidisation has proved that nothing escapes it. Built for ease of use – simply set and relax!

With the Quantum you are in complete control.

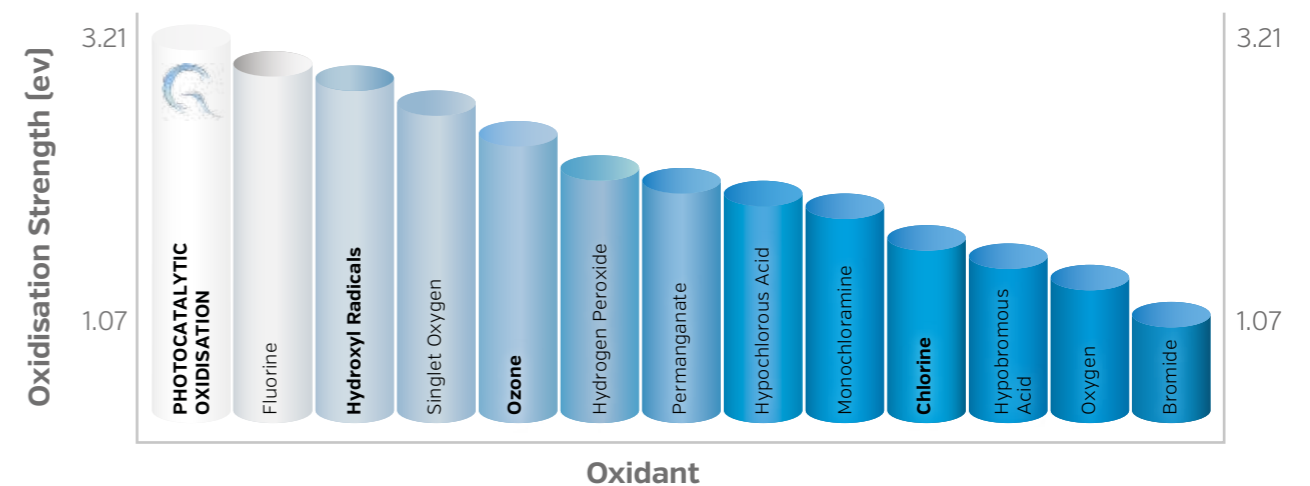

HOW DOES IT WORK? THE SCIENCE.

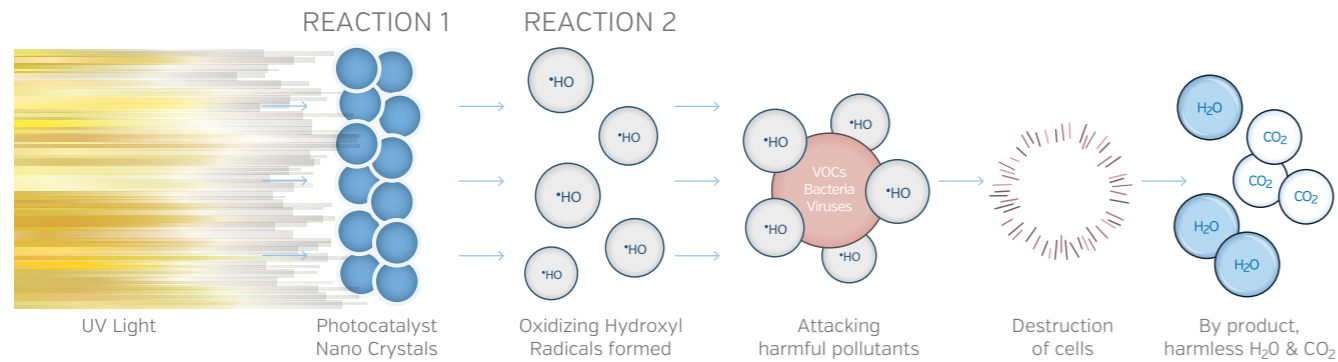

Reaction 1: Quantum Photocatalytic Oxidiser (PCO)

The primary function of the Quantum is oxidation by photocatalytic reaction. Within the Quantum reaction chamber is a catalyst assembly, ionically bonded with a coating of Anatase, Silver and Platinum Nano Crystals. Ultra-violet light at the wavelength of 254nm strikes the catalyst surface creating an abundant reaction of the atoms' electrons in the coating, creating the strongest sterilising effect known to man. It also alters the water to create hydroxyl radicals. Photocatalytic oxidation (PCO) has two effects - it will:

- **Oxidise and destroy any pollutant, either biological or non-biological, close to the catalyst surface**
- **Oxidise the water into hydroxyl radicals**

Reaction 2: Hydroxyl Radicals (HO)

Hydroxyl Radicals are essentially a water molecule with a Hydrogen atom removed, and a highly reactive, unpaired electron, caused by the PCO reaction, disturbing the electrons and forming holes in the valance band of the atom.

The exceptionally mobile molecules that fill the reaction chamber are highly volatile and able to destroy everything in their path. Once the Hydroxyl Radical has reacted with the pollutant it converts back into water:



It's true that Hydroxyl Radicals can be made in many ways, however instead of using more chemicals that are damaging to health, the Quantum utilises photocatalytic oxidation. This is the **safest** and **most effective** method against pollutants.

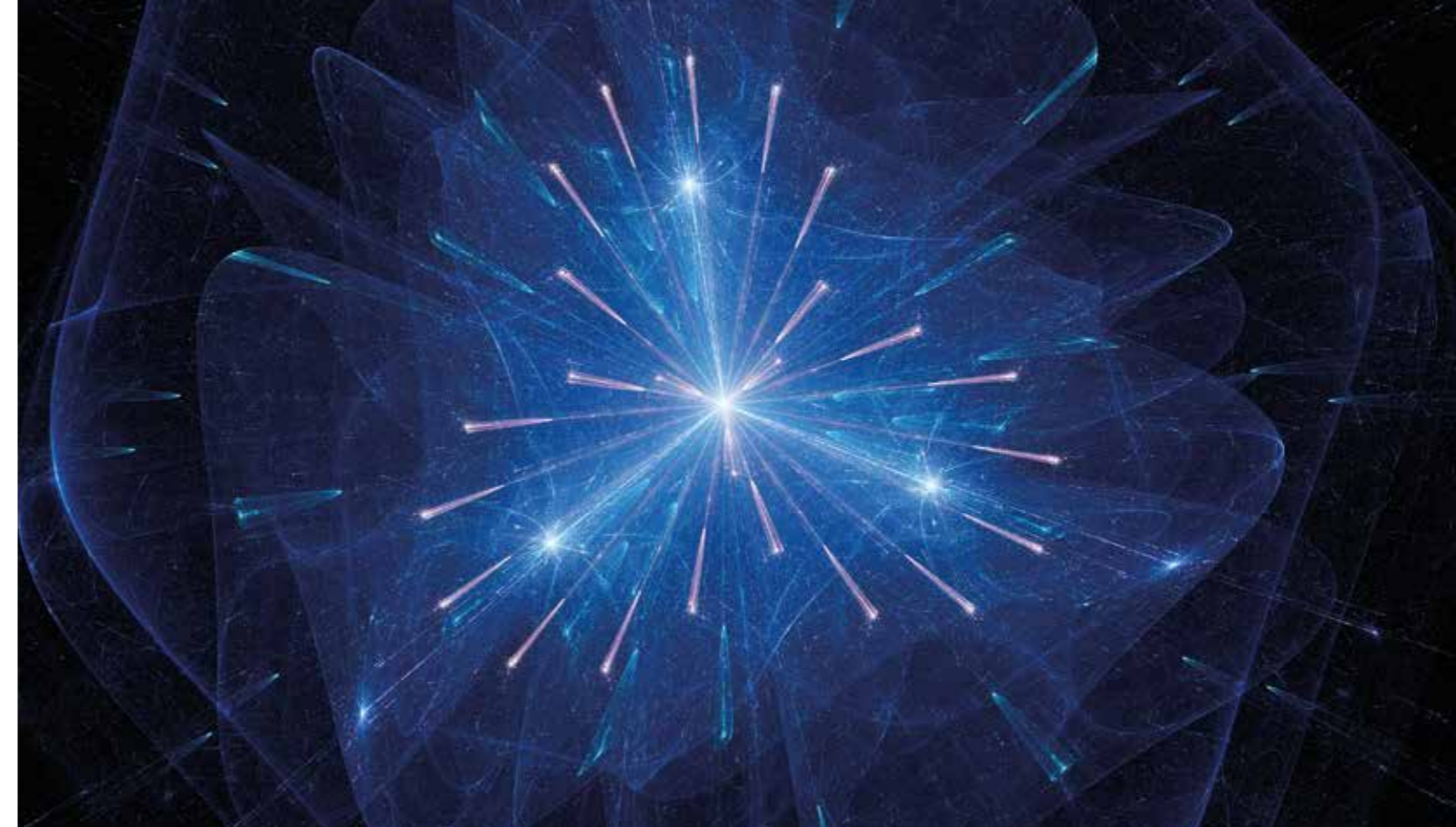

Intelligent Peristaltic Dosing Pump Option:

The Quantum has the option of being supplied complete with integral intelligent peristaltic dosing pump which is pre-programmed to dose Hydrogen Peroxide [Active Oxygen]. Featuring:

- **Temperature Sensor:** The water temperature is monitored and the dosing amount is automatically adjusted according to the water temperature. No ongoing adjustments required.
- **Flow Switch:** The dosing will only be started when there is a consistent water flow being delivered to the unit.
- **Automated:** Dosing is set to take place at a desired time every day.
- **Digital lamp life countdown timer & Neon indicator:** Green = OK, Amber = under 500 hours remaining, Red = Lamp change required.
- **Lamp** will be automatically switched off during the dosing period and for 30 minutes immediately after [ensuring that the Hydrogen Peroxide is entering the pool and not consumed within the reaction chamber].

INSTALLATION & SIZE GUIDE

The Quantum can be easily installed into your new or existing pool system.

Compared to other products in the market place, Quantum offers superior performance at reduced levels of power consumption. On this basis we recommend:

- Single tube [55W input] for up to 65m³ volume of swimming pool
- Double tube [110W input] for up to 130m³ volume of swimming pool

Installation is quick and easy and can be fitted directly into your new or existing system, using the pre-assembled threaded unions. The Quantum is integrated with all controls and flow switch, along with the option of a peristaltic pump and temperature probe ensuring accurate dosing. Giving the pool owner peace of mind that they are choosing a natural, effective sanitiser that once installed requires no further adjustments.

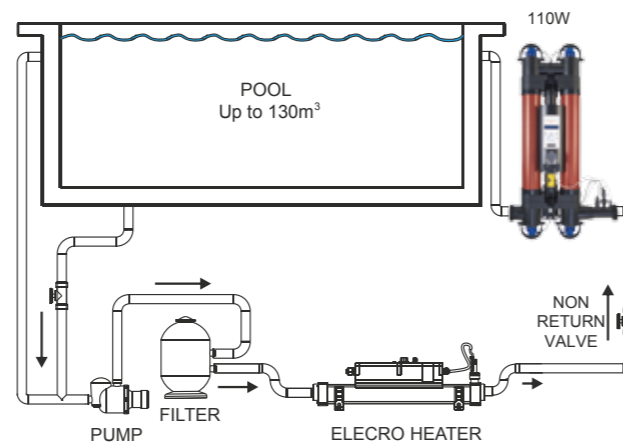
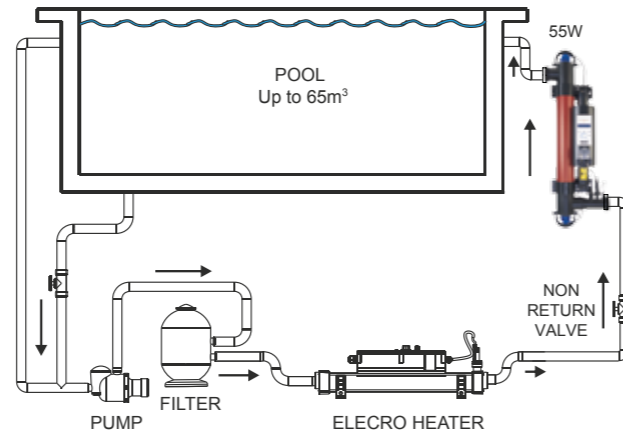

DIMENSIONS (MM)

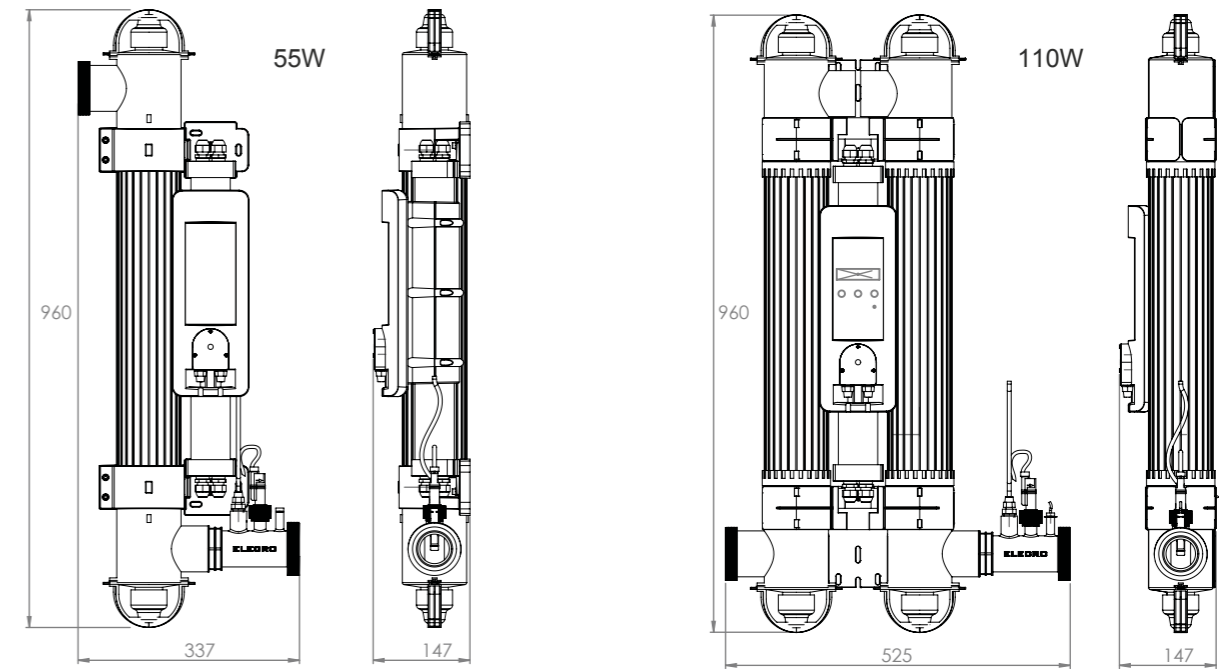

MODEL OPTIONS

All Quantum units are supplied complete with flow switch and either an analogue lamp life indicator and reset switch, or digital lamp life countdown with intelligent dosing pump.

Product Code	Lamp Output	Max Pool Volume	Features
Q - 65	55W	65m ³	Analogue Lamp Life Indicator & Reset Switch
Q - 130	110W	130m ³	Analogue Lamp Life Indicator & Reset Switch
QP - 65	55W	65m ³	Digital lamp life countdown with Intelligent dosing pump
QP - 130	110W	130m ³	Digital lamp life countdown with Intelligent dosing pump

Product Code Suffix -UK = UK Plug / -EU = European Plug

TECHNICAL SPECIFICATION

Voltage and frequency	220V ~ 240V 50/60Hz or 110V ~ 120V 50/60Hz
Maximum operating pressure	3 bar
Max. power consumption	Single Tube: 64W Double tube: 128W
Lamp	Low pressure / High output
Lamp life	14,000 hours
Minimum flow rate	4,000 litre per hour [4m ³ /h]
Maximum flow rate	Single Tube: 14,000 litres per hour [14m ³ /h] Double Tube: 28,000 litres per hour [28m ³ /h]
Maximum pool size	Single Tube: 65,000 litres [65m ³] Double Tube: 130,000 litres [130m ³]
IP rating	IP65
Water connections	2" / 63mm stepped + reducers 1½" / 50mm
Dosing rate	Exceeds the equivalent of 30mj/cm ² at maximum flow rate
Salt water	100% sea water safe
Approvals	CE approved
Oxidisation processes	Quantum photocatalytic oxidiser [PCO] & hydroxyl radicals [OH]

DID YOU KNOW?



The Anatase, Silver and Platinum catalyst in Quantum uses the same technology that was used to clean up the oil spill in the Gulf of Mexico. The catalyst was attached to hollow polyester fibre and floated on the surface of contaminated water. It has also been used to sterilise lakes, rivers and even sewerage.



It is a misunderstanding that ozone gas in the ozone layer sterilises the earth's atmosphere. In fact 85% of the sterilisation effect is actually a result of UV rays from the sun creating Hydroxyl Radicals on the surface of clouds.





QUANTUM

P U R I T Y

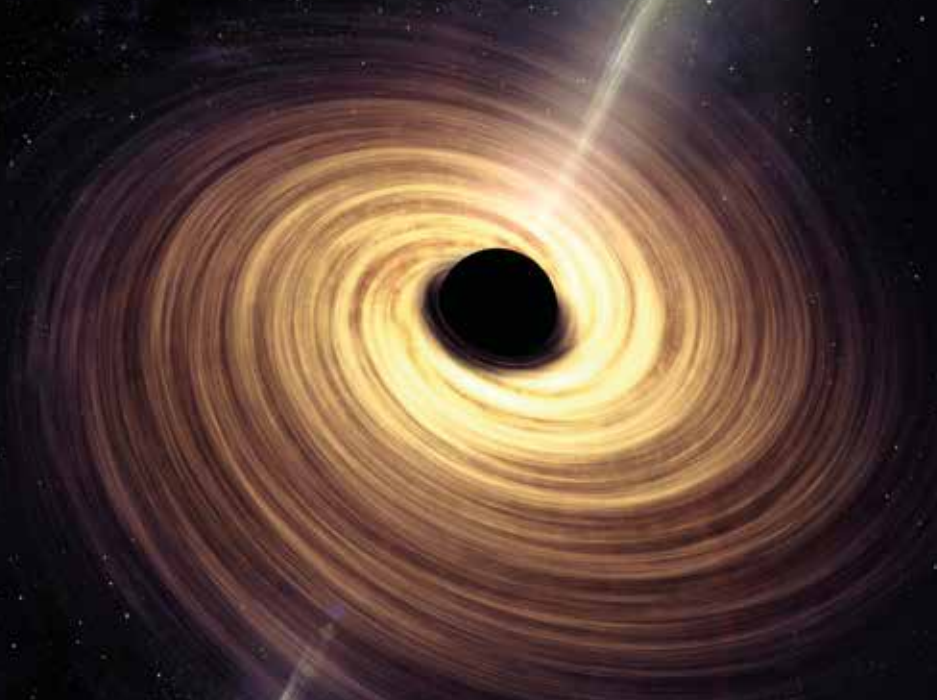

ELECRO
ENGINEERING

www.elecro.co.uk

Unit 11 Gunnels Wood Park, Gunnels Wood Road,
Stevenage, Hertfordshire, SG1 2BH, United Kingdom

T: +44 (0)1438 749 474 | F: +44 (0)1438 361 329 | E: sales@elecro.co.uk